

DE 3 EN 3

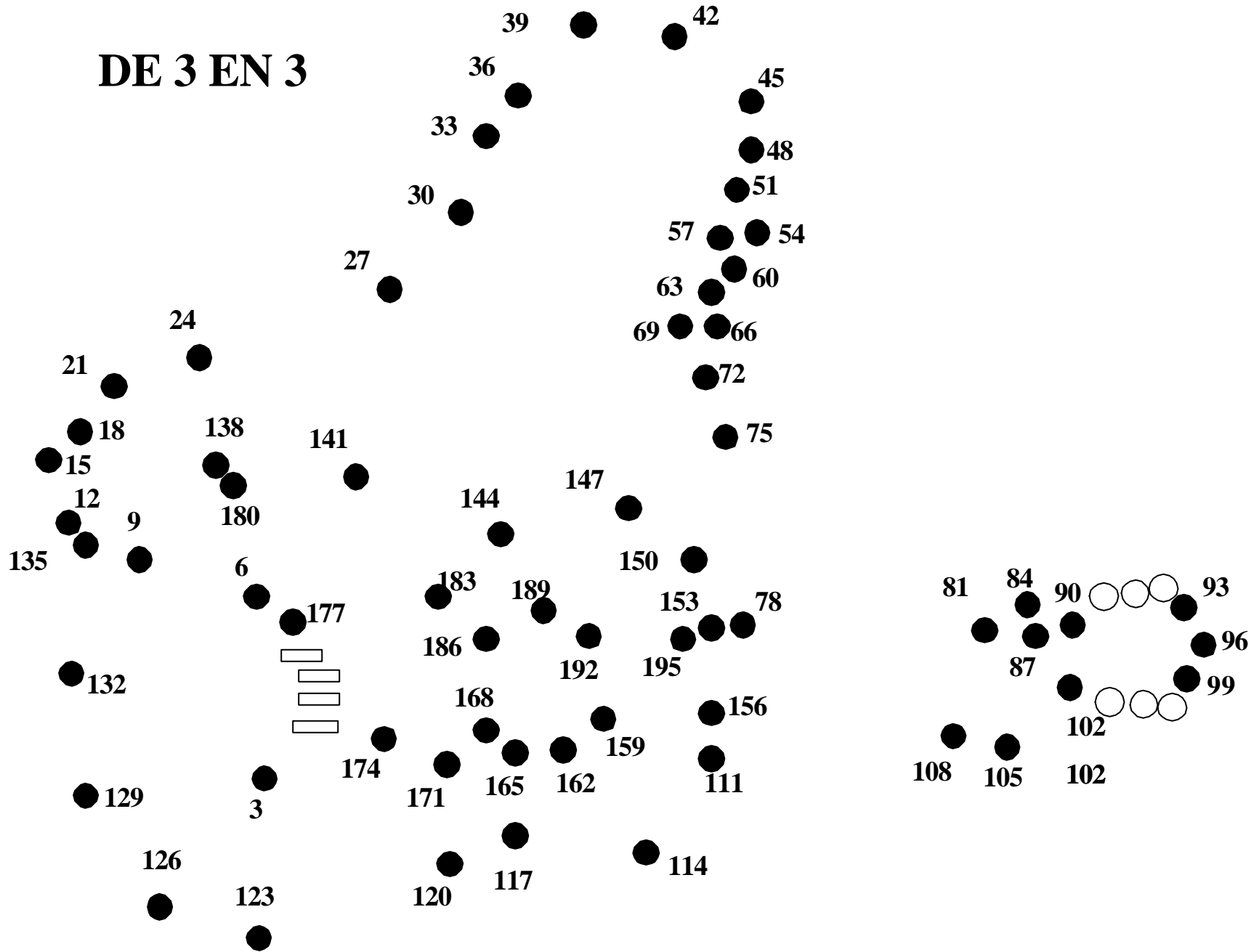

DE 4 EN 4

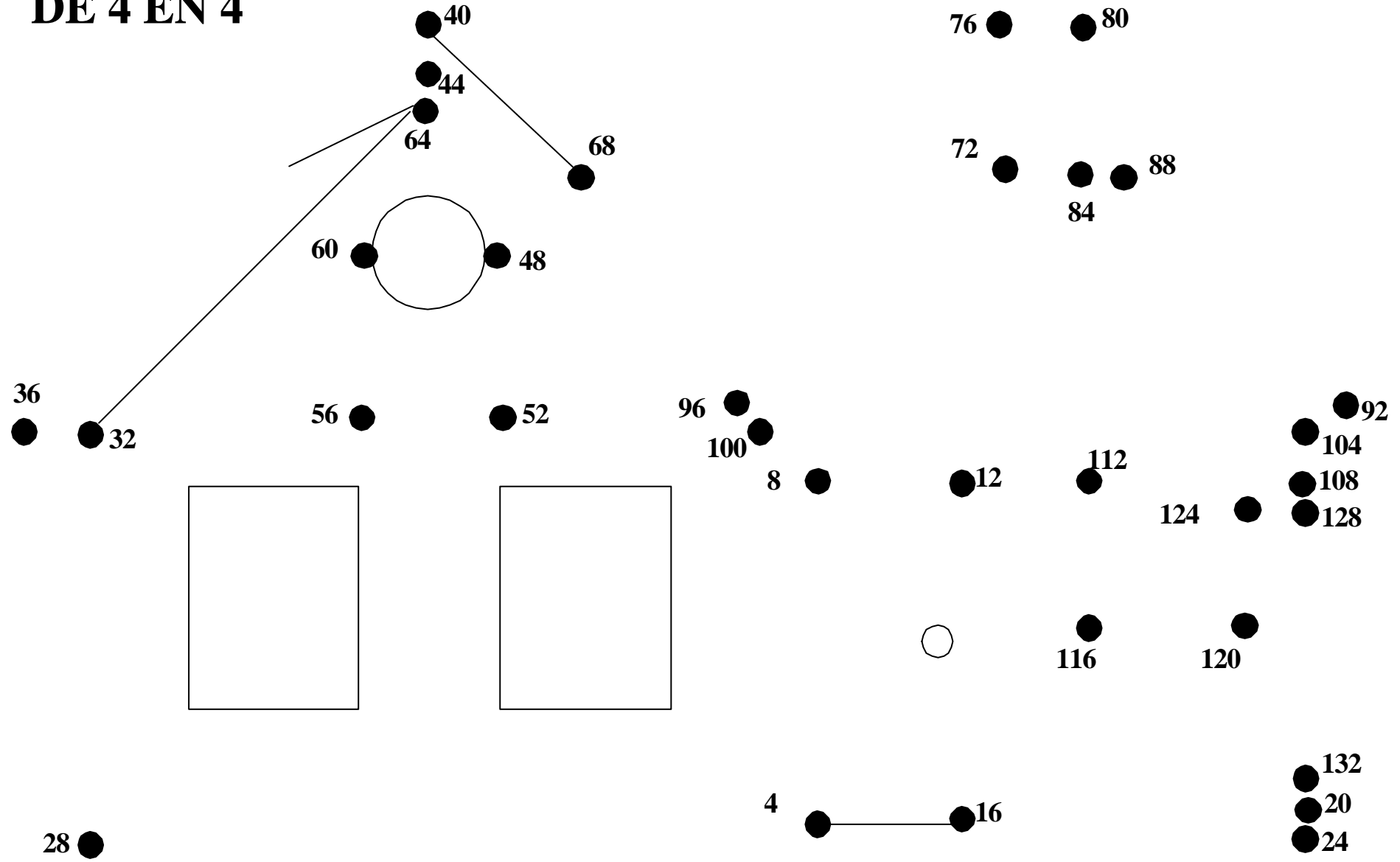

NOMBRES PARELLS

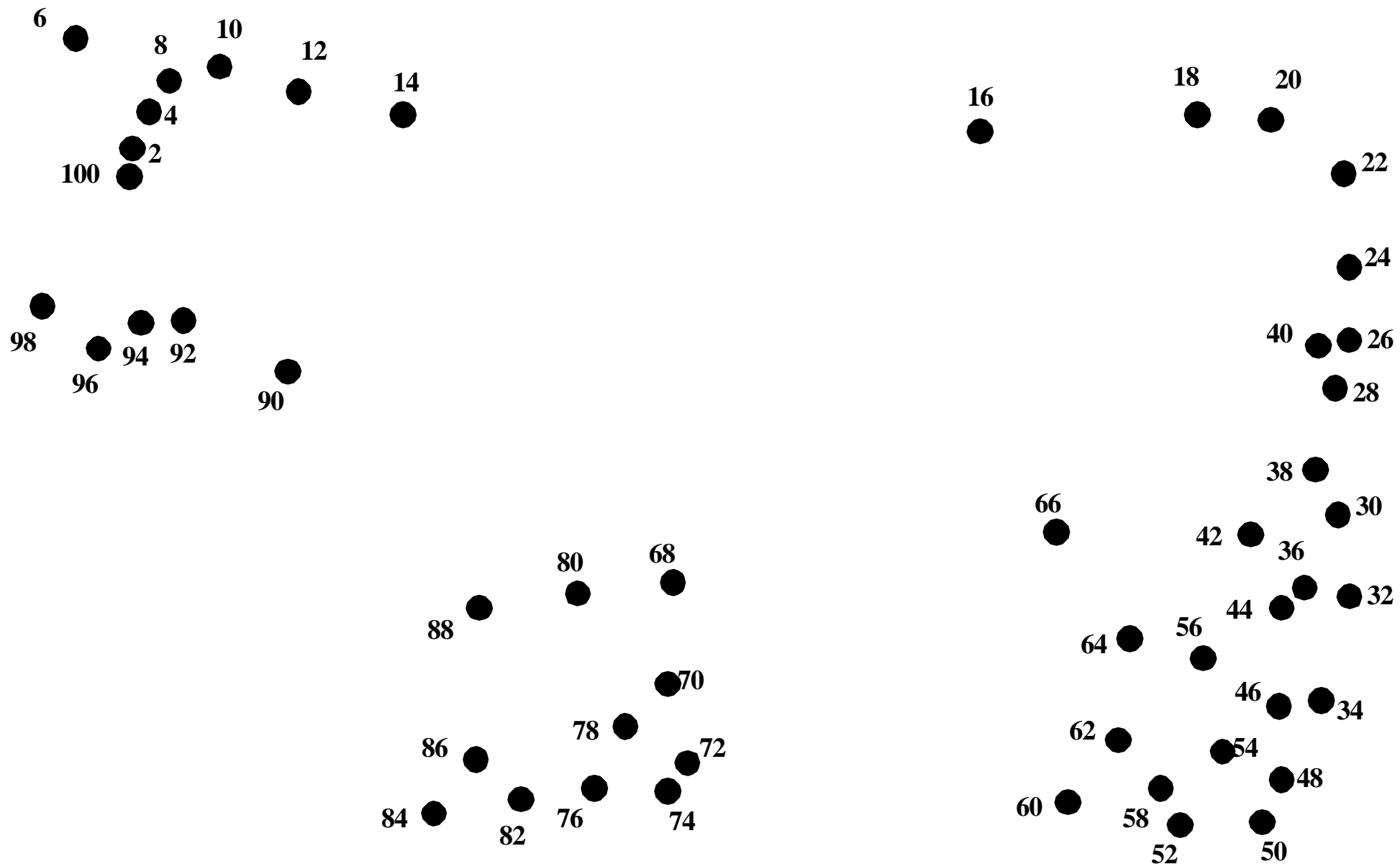

NOMBRES SENARS

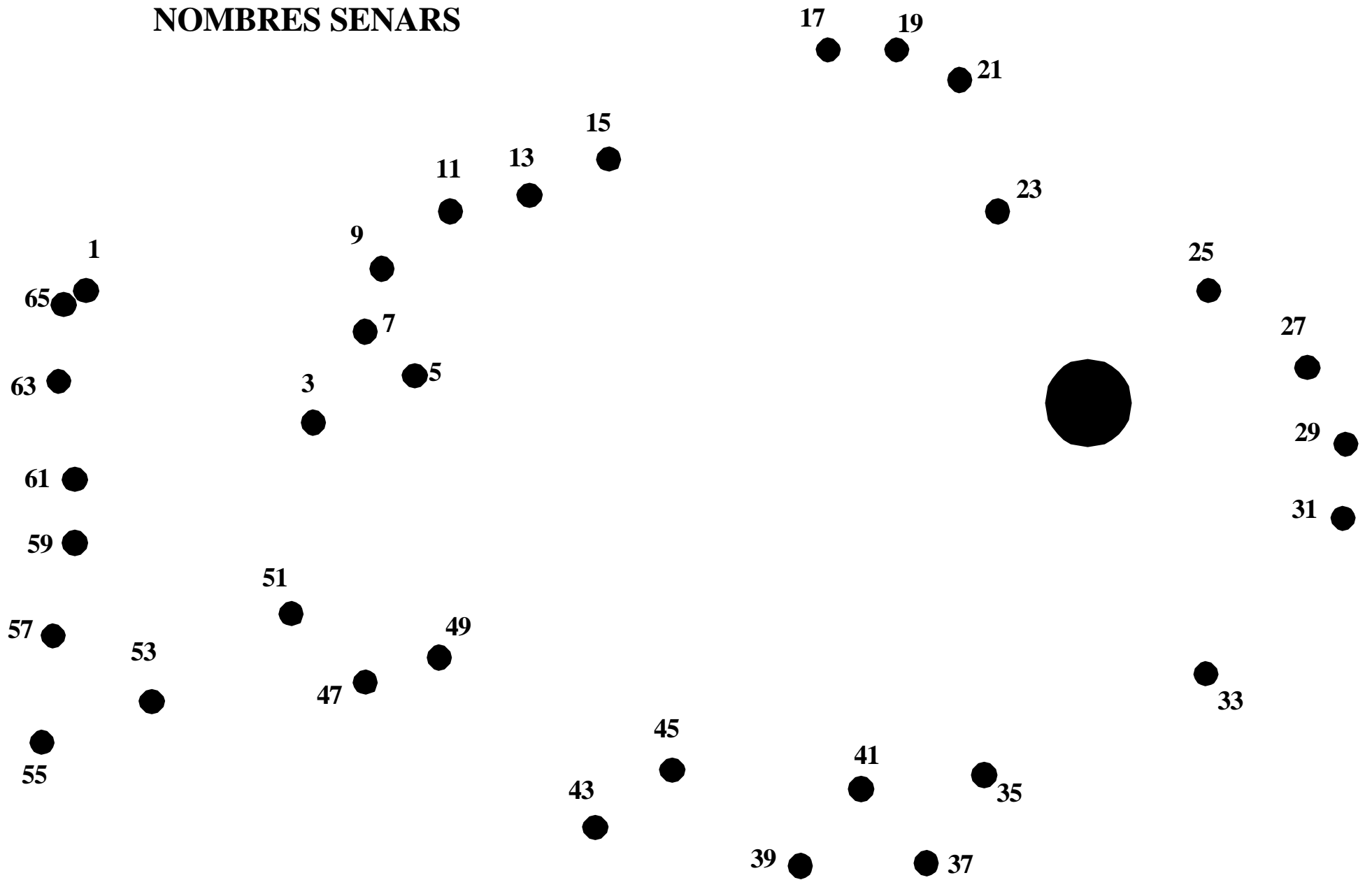

**Parells per un costat.
Senars a l'altre costat.**

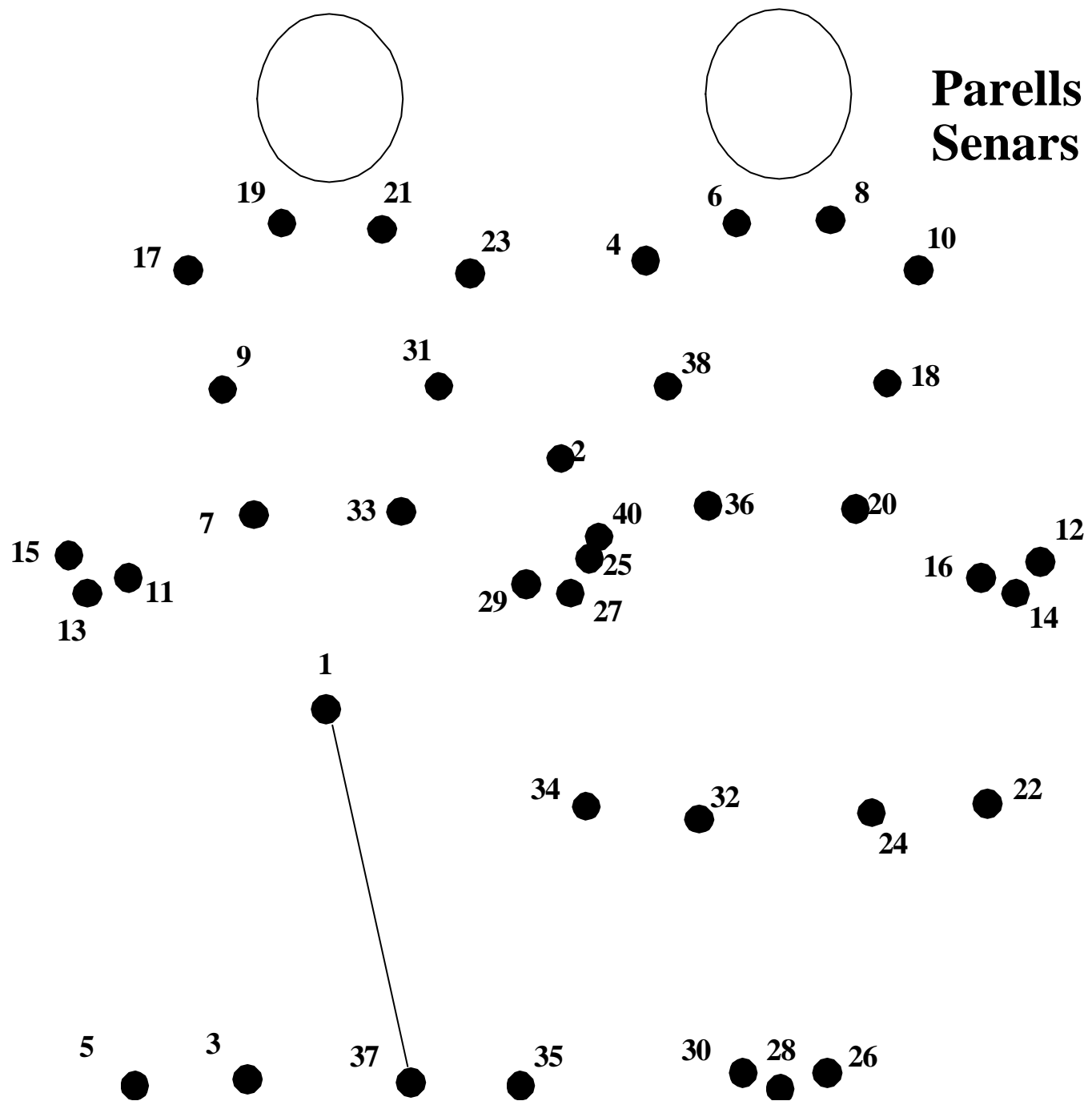

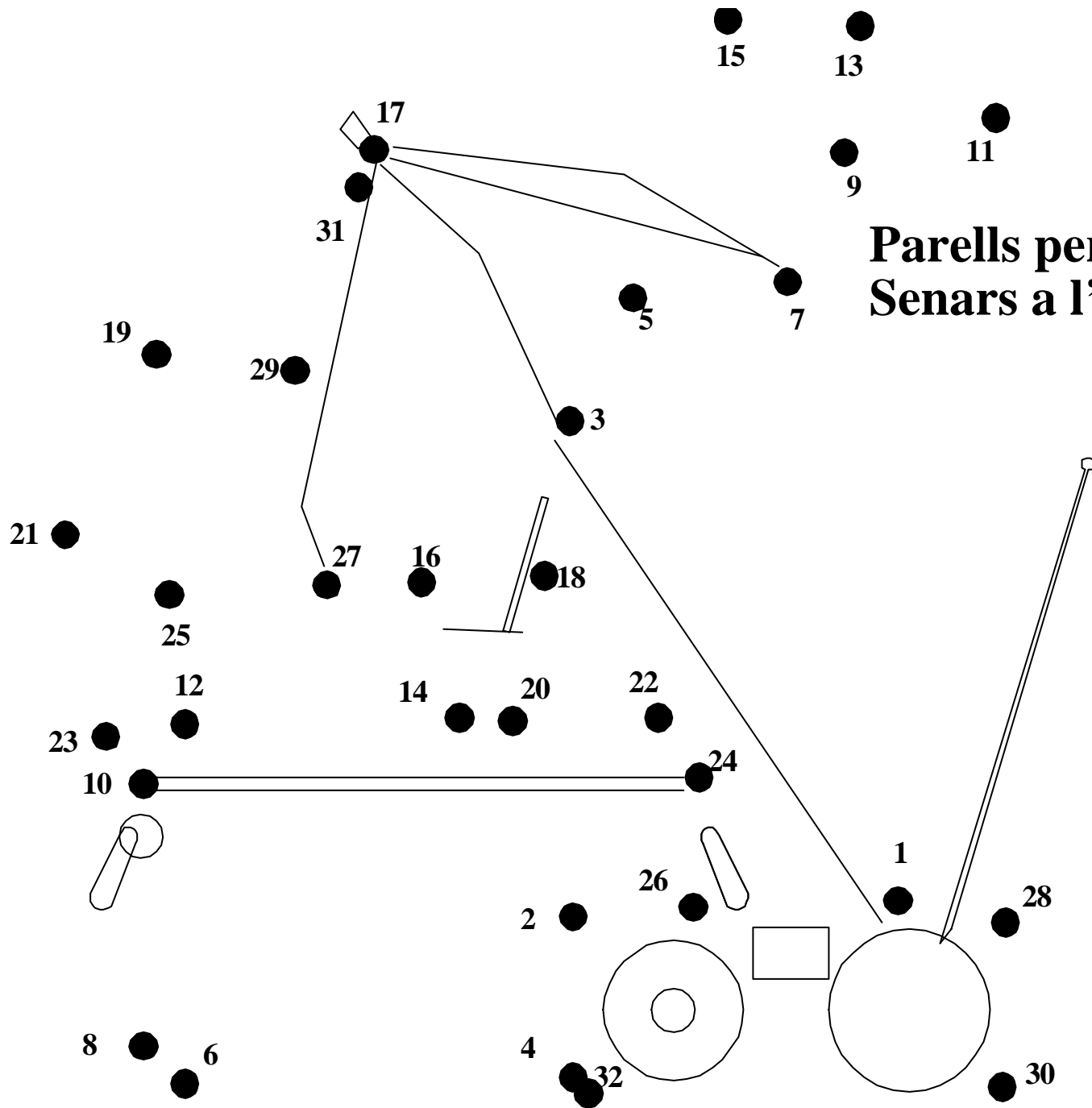

**Parells per un costat.
Senars a l'altre costat.**

De I a XX

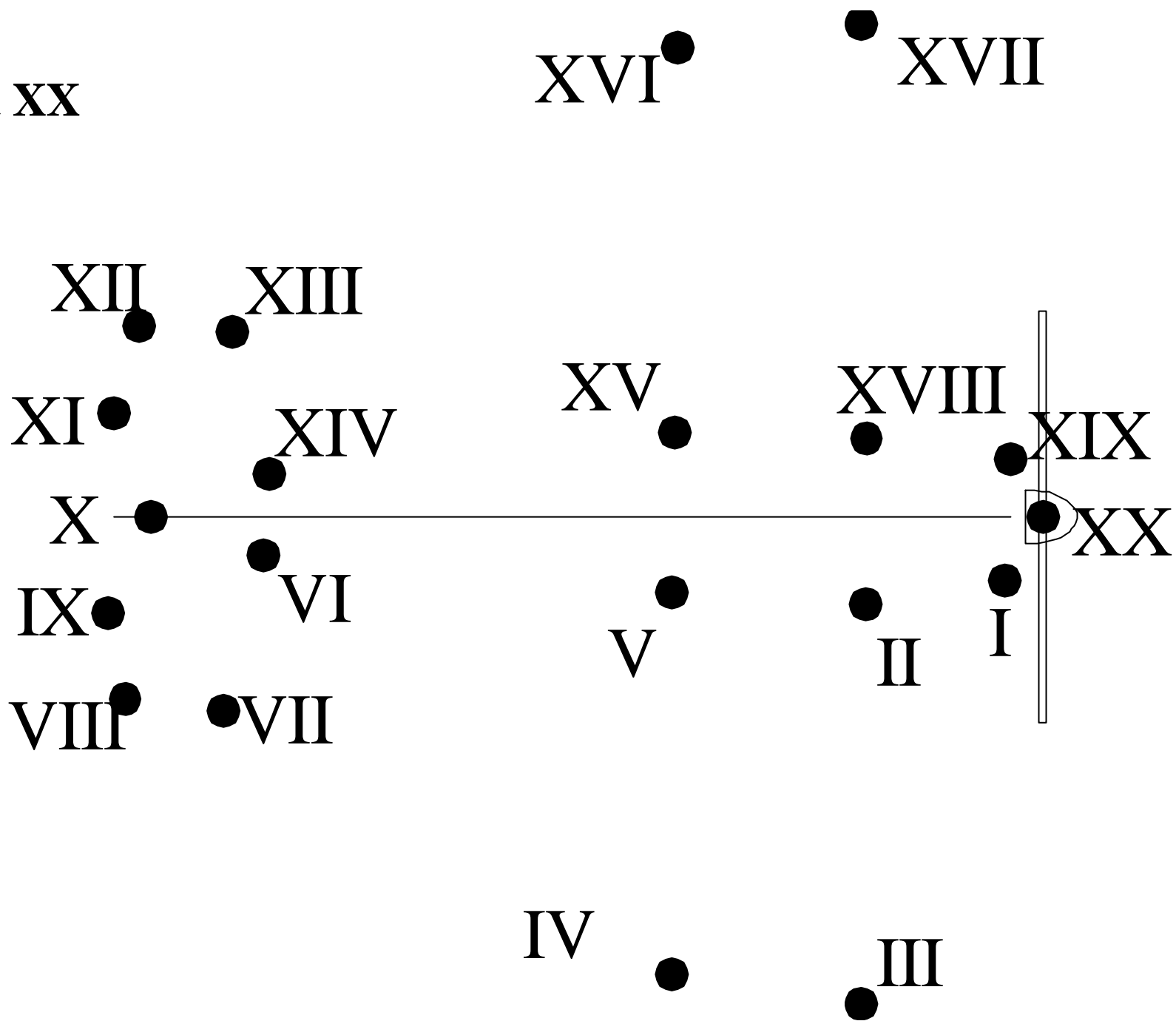

De I a XX

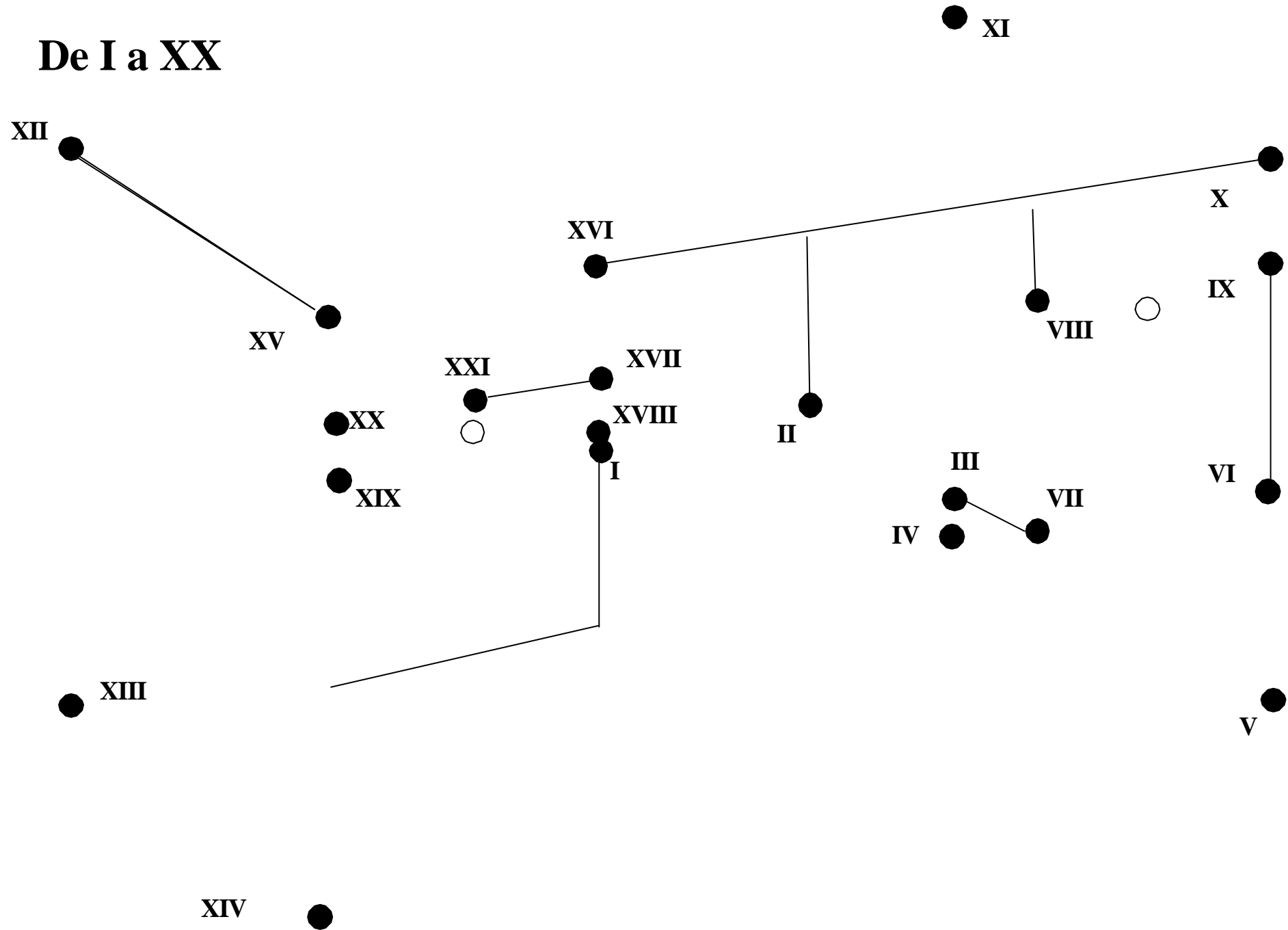

De V a CLXXXV de V en V

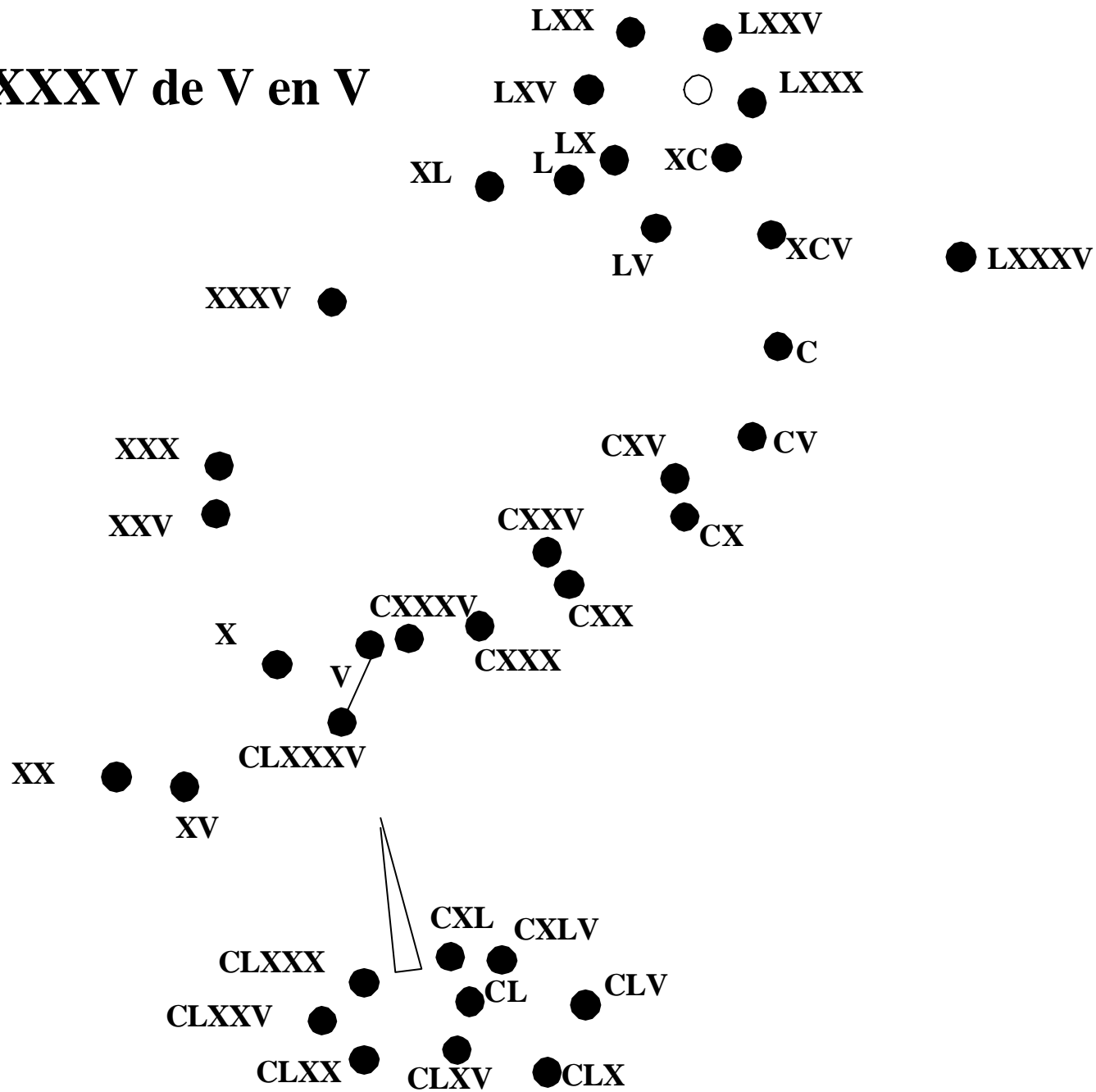

De X a CCLXXX de X en X

● XC
● C
● CX

● CXX

● CXXX

● CXL

● CLX

● CLXXX

● CLXX

● CC

● CXC

● CCXX

● CCXXX

● CCX

● LXX
● LXXX ○

● LXX

● LX

● L

● XL

● XXX

● XX

● CCLX

● CCL

● CCXL

● CCLXX

● CCLXXX

● X

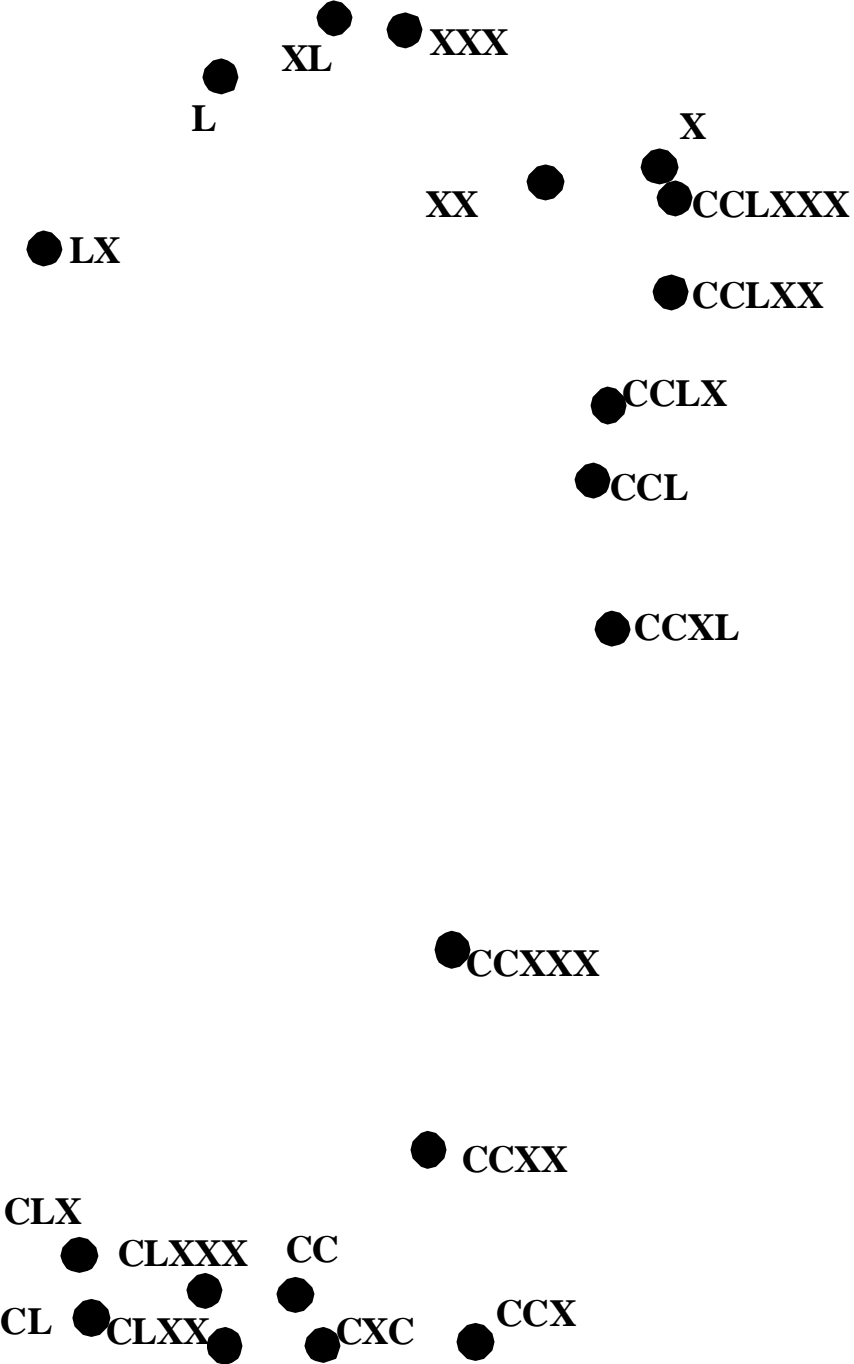

(-,+)

Localitzeu els objectes a les coordenades

(+,+)

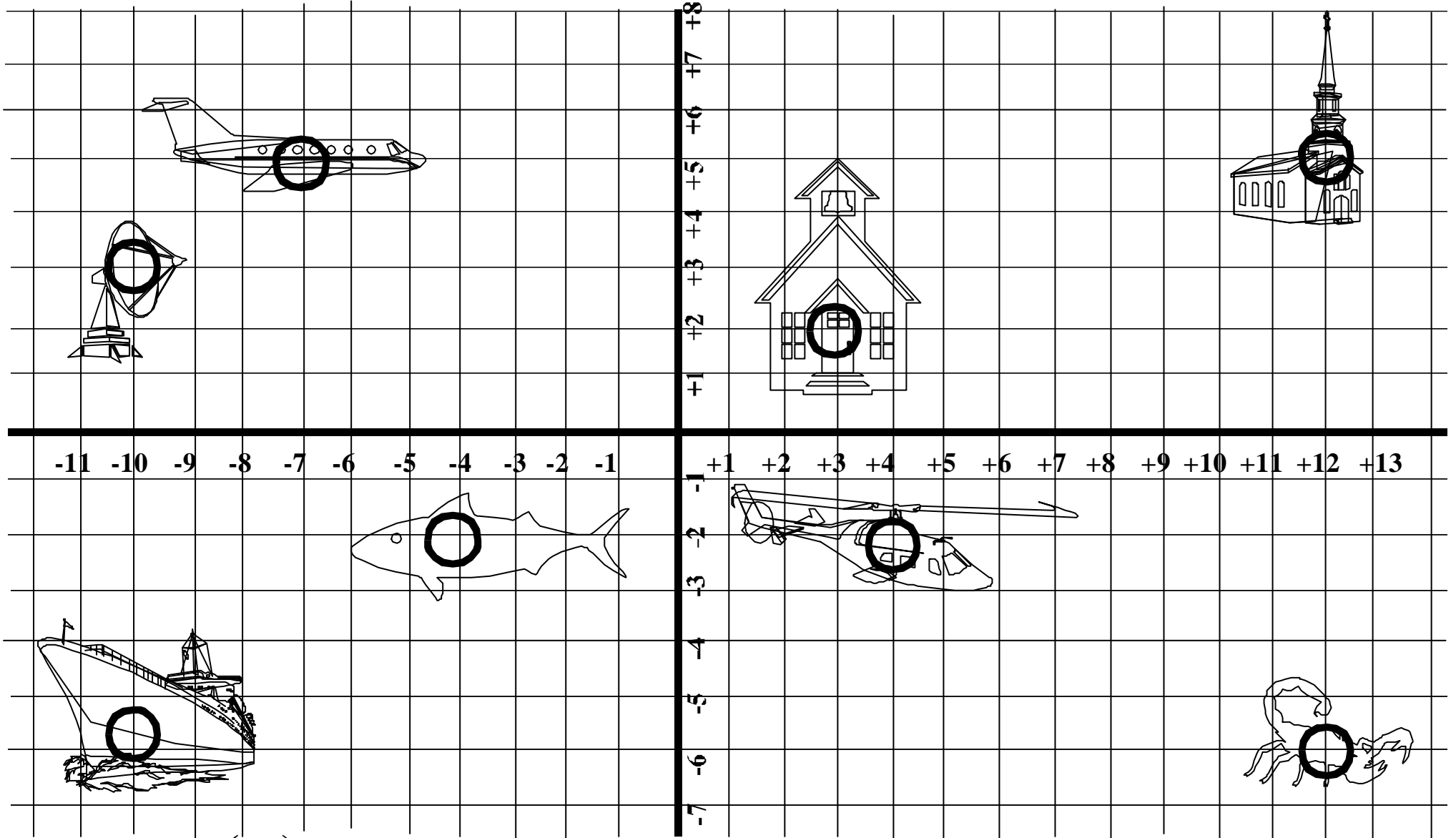

(-,-)

(+,-)

(-,+)

Localitzeu els objectes a les coordenades

(+,+)

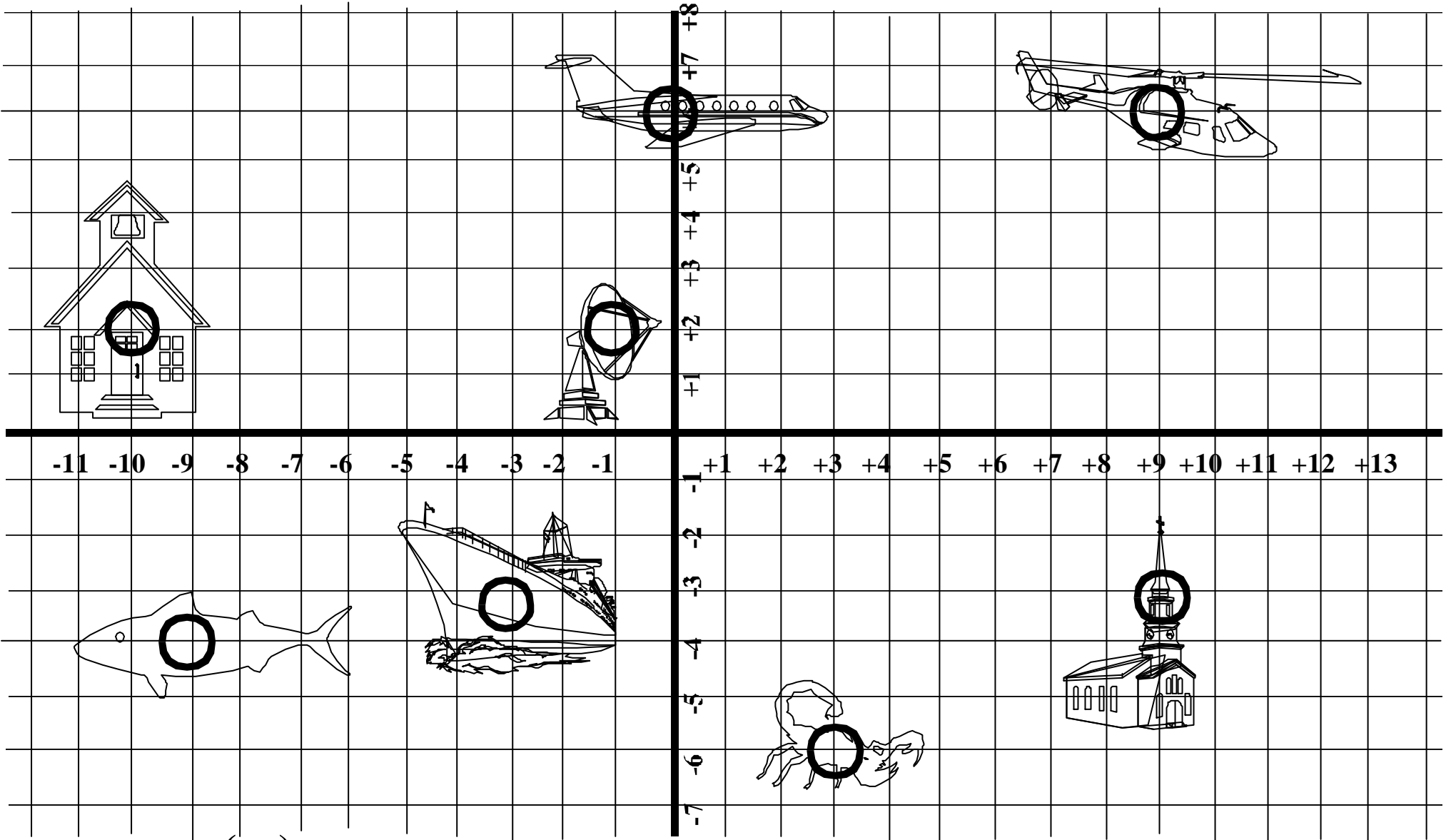

(-,-)

(+,-)

Localitzeu els punts següents i després enllaceu aquests punts amb línies:

(+2,+4), (+2,+1), (-7,+1), (0,-9), (-11, +1), (-12, -1), (-11,-3), (-9,-2), (-3, -3), (+14,-3), (+14,+1), (+5, +1), (+4,+4)

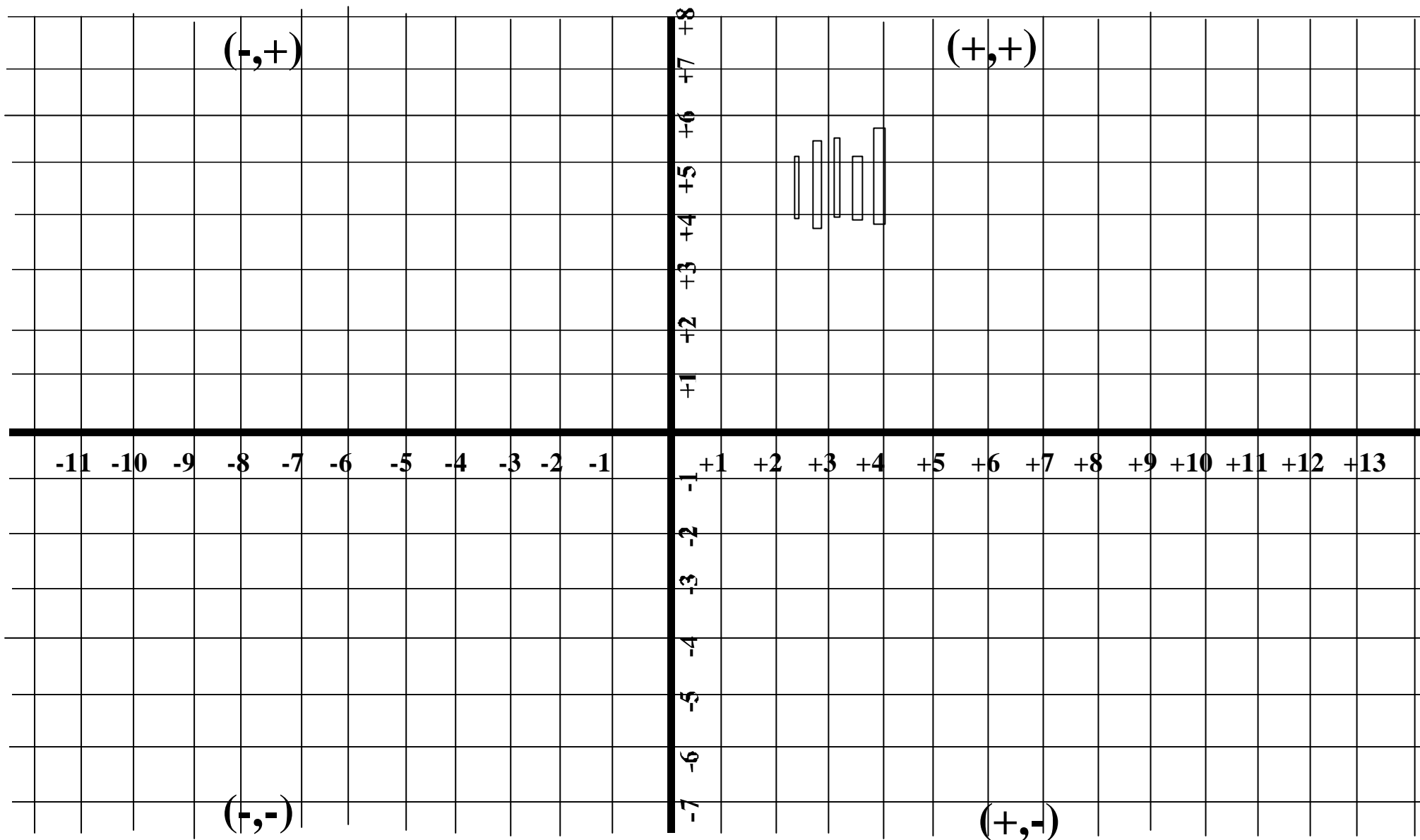

Localitzeu els punts següents i després enllaceu aquests punts amb línies:

(+9,0), (+11,+4), (+10,+4), (+8,+2), (+6,+3), (+6,+7), (+4,+7), (+1,+2), (-3,+1),

(-8,0), (-3,-1), (+1,-2), (+4,-7), (+6,-7), (+6,-3), (+8,-2), (+10,-4), (+11,-4)

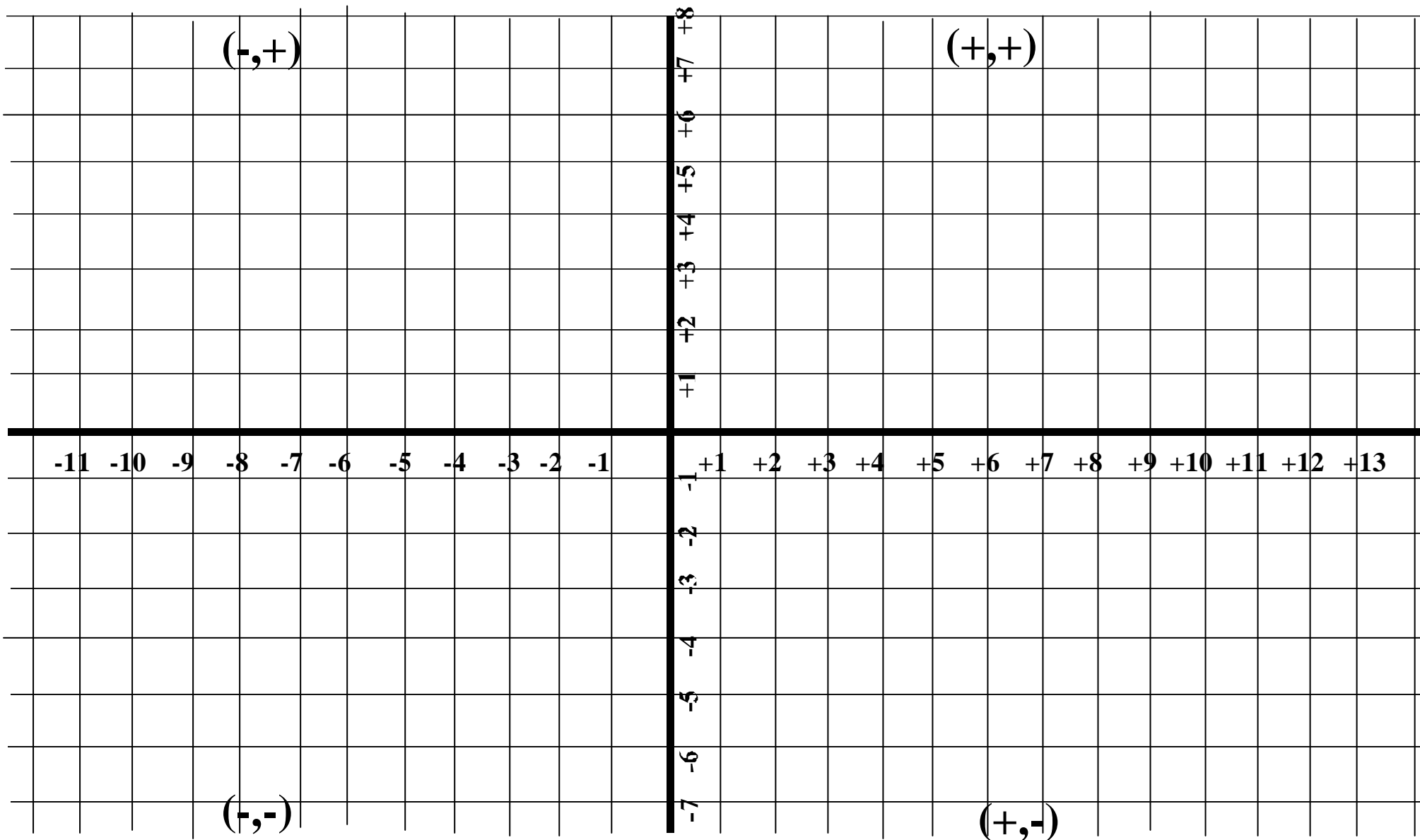

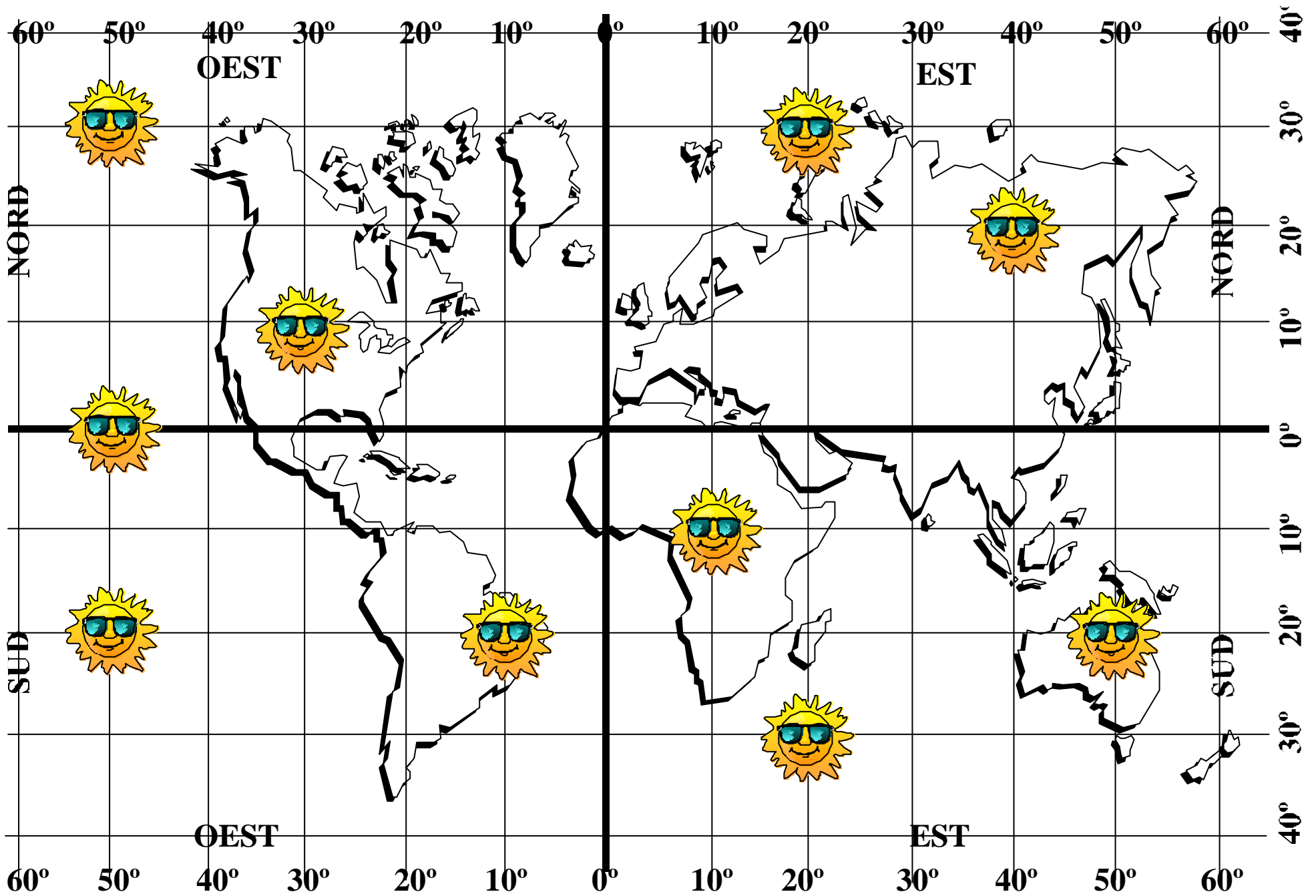

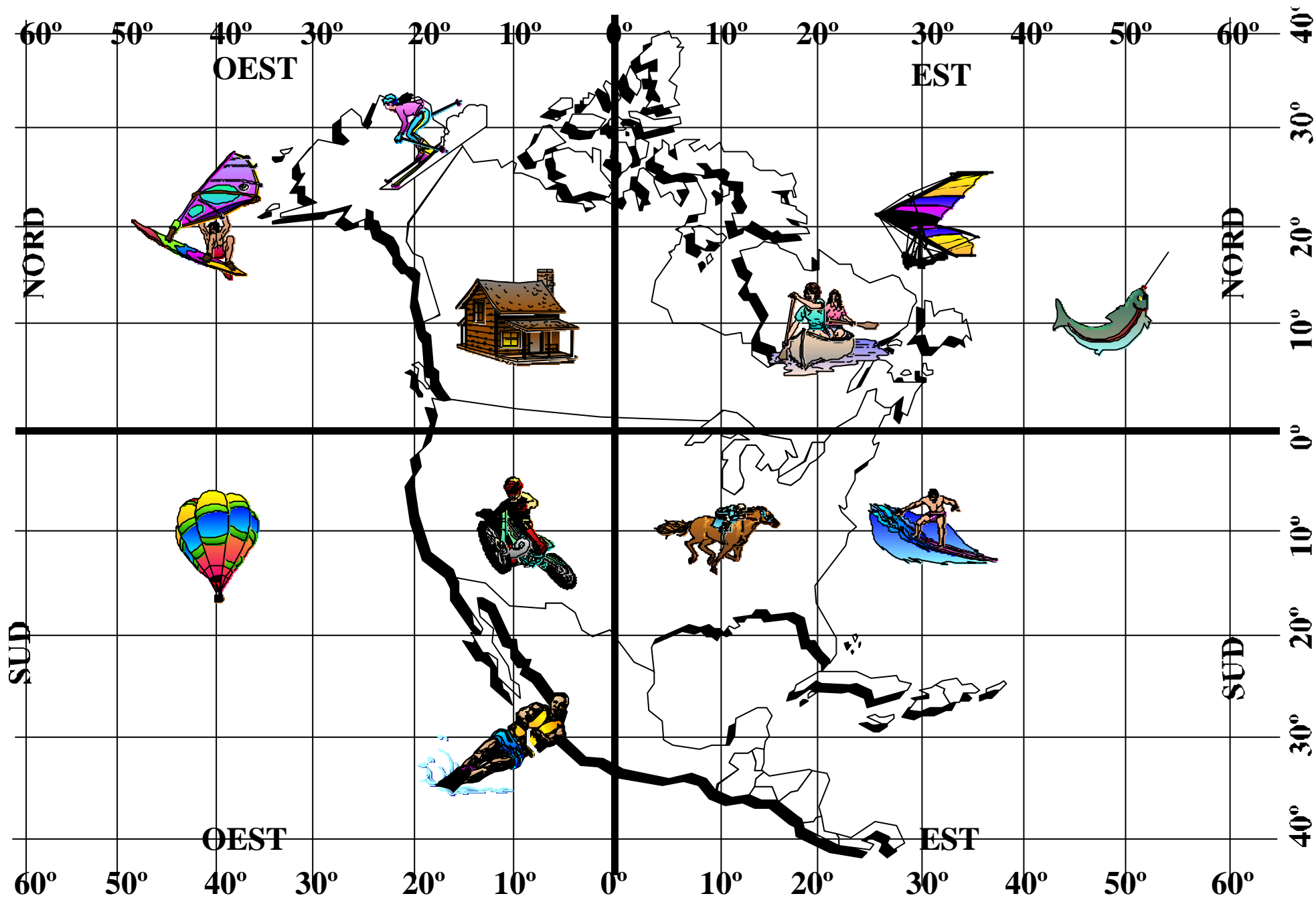

TAULA DE PREUS EN EUROS

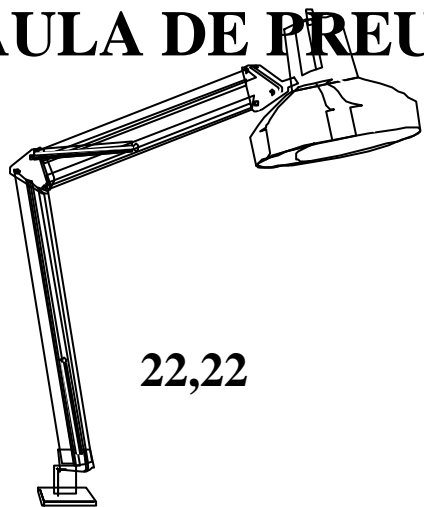

22,22

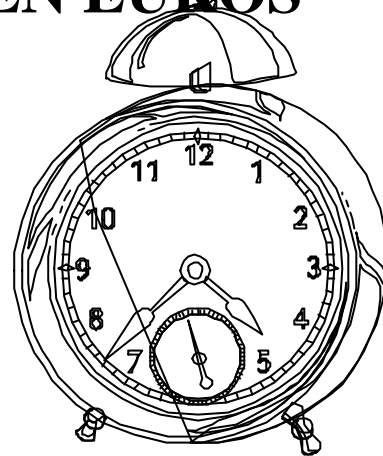

15,55



99,99



55,55

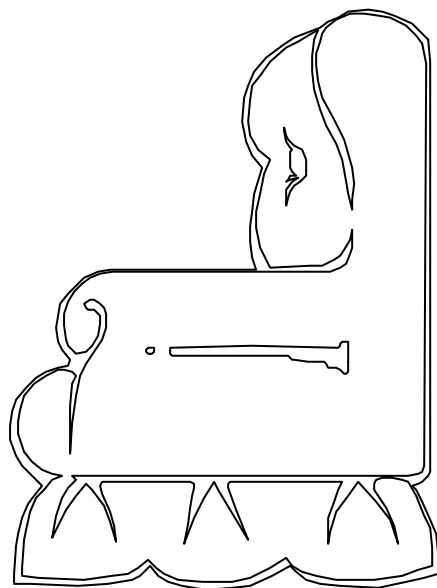

88,88

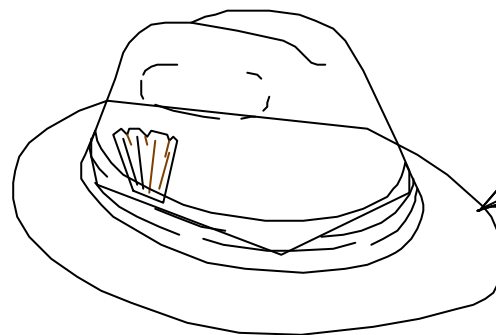

11,11

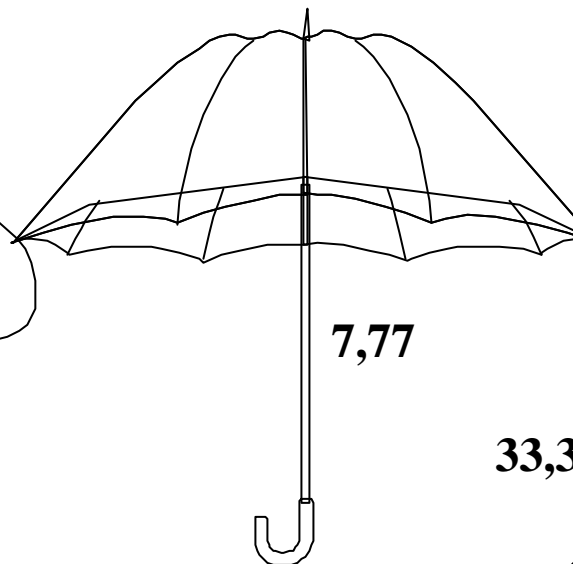

7,77

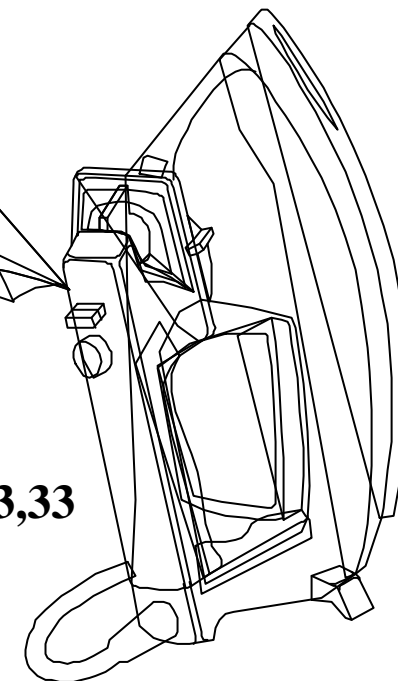

33,33

EFFECTUA LES SUMES SEGÜENTS

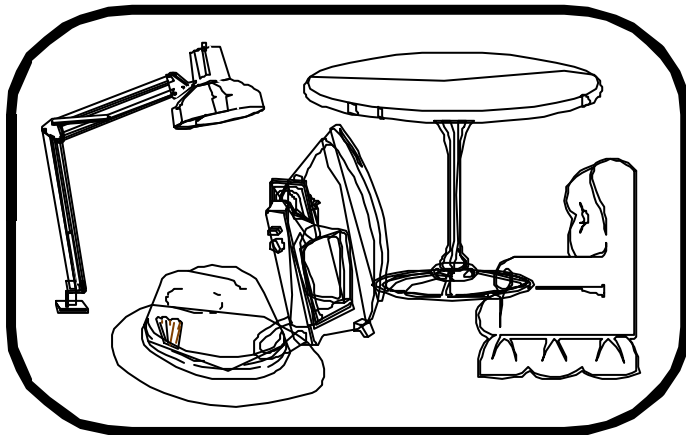
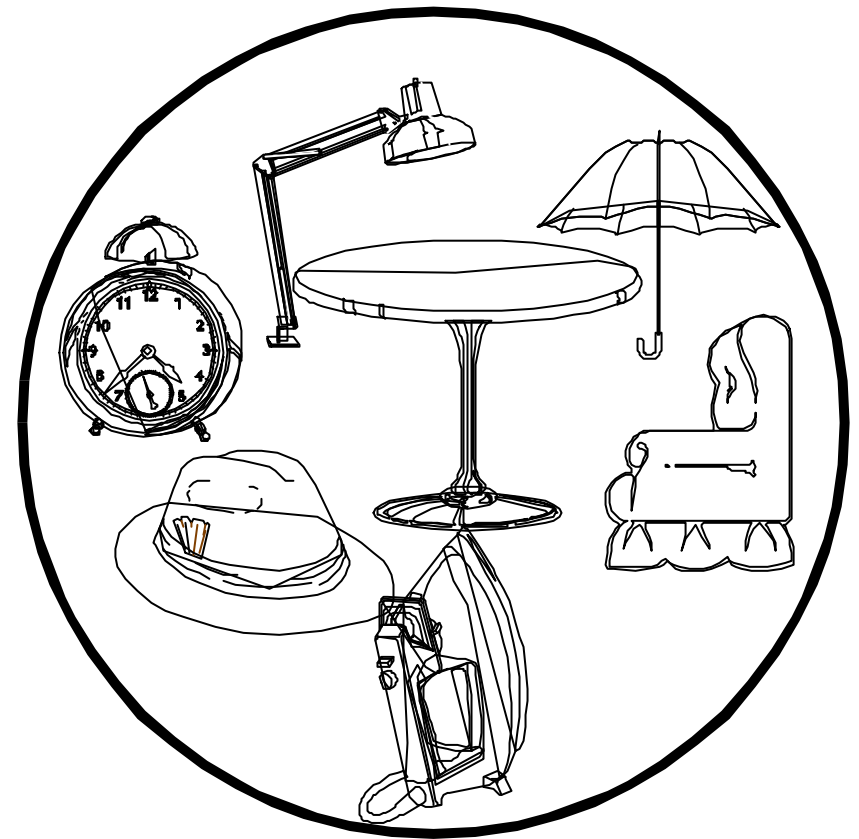
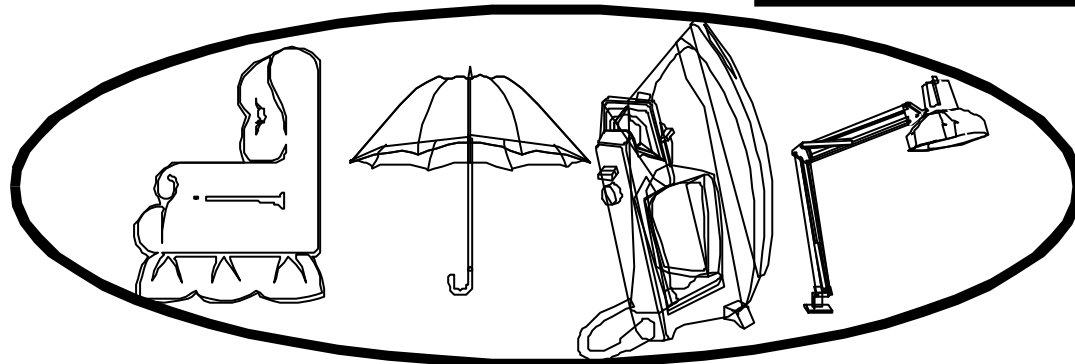
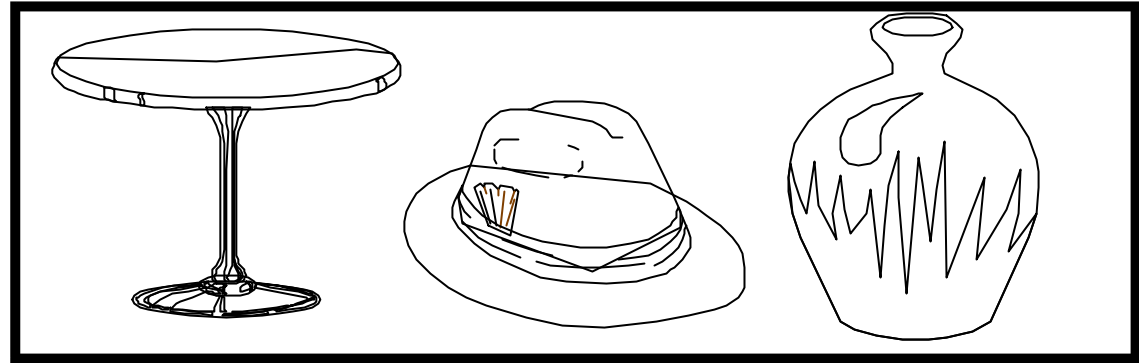
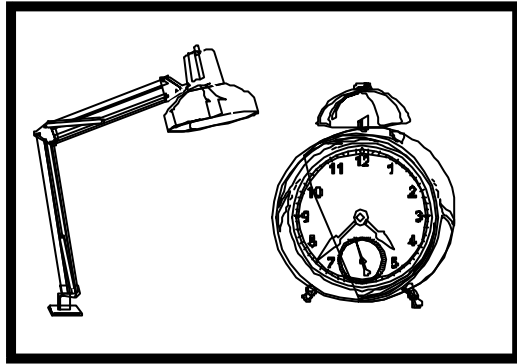

SUMES I RESTES AMB RESULTATS CURIOSOS

8459

+ 54896

+ 223344

+ 824412

+ 12345

+ 67890

+ 8653

97865

- 75643

90909

- 46465

MULTIPLICACIONES AMB RESULTATS CURIOSOS

$$6172839 \times 2 =$$

$$29218107 \times 3 =$$

$$11111 \times 5 =$$

$$142857 \times 7 =$$

$$3367 \times 66 =$$

$$47619 \times 7 =$$

$$3367 \times 33 =$$